



Roofnest Condor 2 Wall Kit

Install and Setup Instructions

Condor 2 Wall Kit Installation Guide

What is included

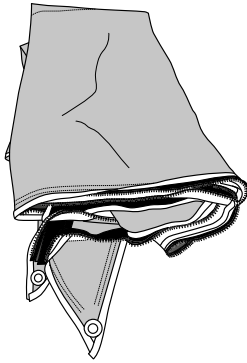

• 1x Awning

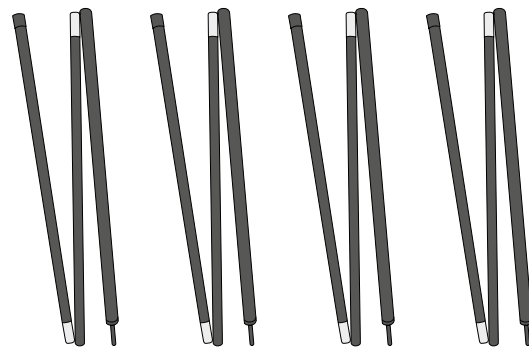

• 4x Fixed Length Poles

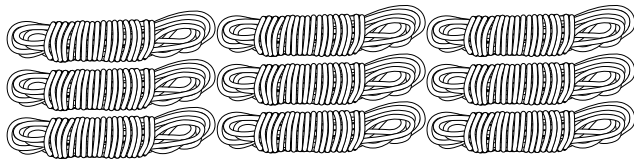

• 9x Guy Lines

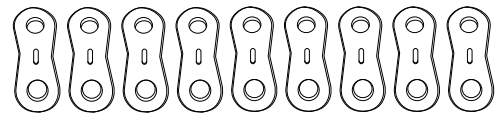

• 9x Guy Lines Tensioners

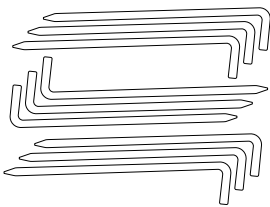

• 9x Stakes

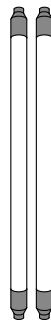

• 2x Strut Locks

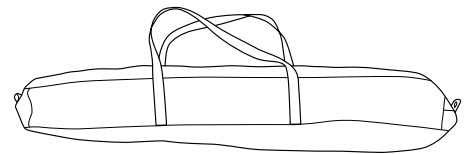

• 1x Storage Bag

Follow the instructions on setting up your Condor 2/Condor Overland 2

Preparing to up set the awning for the first time.

- Prepare the Guy Lines (9x).

- a. Insert the Guy Line through one of the holes in the Guy Line Tensioner. Create a loop and tie the end off to the remaining Hole. An overhand knot or half hitch works well.

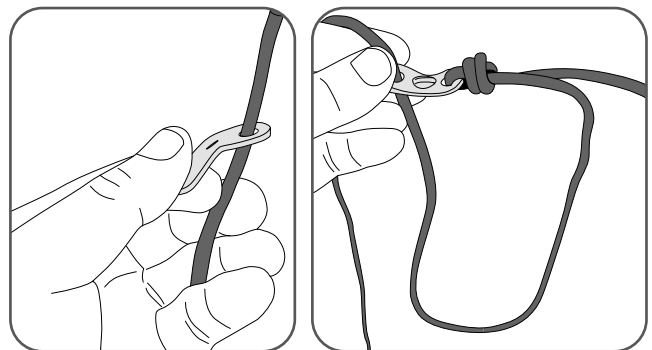

- b. In the opposite end of the Guy Line, tie a loop. A figure 8 knot works well.

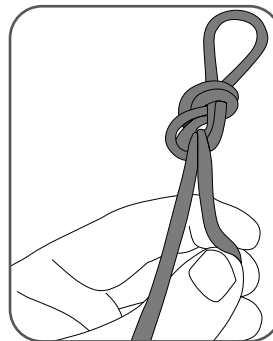

- c. Repeat this process, preparing eight more sets of Guy Lines and Guy Line Tensioners. Set these aside.



The guy lines do not need to be untied after use, they can be stored with both ends tied.

Setting Up the Awning

 It is recommended to have 2 people to set up the Awning.

- Park Vehicle on level ground with enough clearance to fit the footprint of the Awning. Allow for 15 feet from the Latch end of the tent when closed for the awning and guy lines.

Step
1

- Set up Condor 2 Series tent following the instructions. Keep the rainfly U-bar lowered to make installation of the Awning easier.

Step
2

- Unvelcro and unhook the side windows of the rainfly over the front door of the tent.

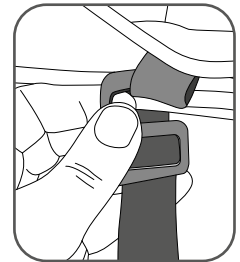

Step
3

- Zip the awning onto the edge of the rainfly, starting on the left side when facing the tent opening.

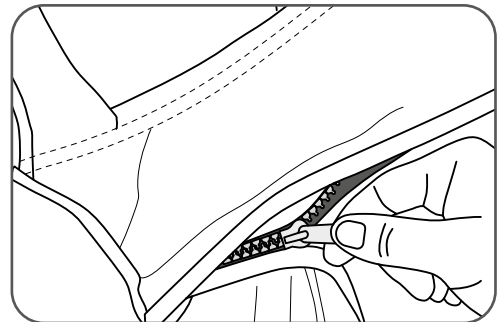

Step
4

- Deploy the rainfly U-bar, making sure it is fully extended.

Once the ladder is properly adjusted and the floor of the tent is secure and flat, climb the ladder and extend the Rainfly U-bar by releasing the levers on each side and pushing the U-bar upward. Once tight, secure the U-bar by adjusting the levers downward.

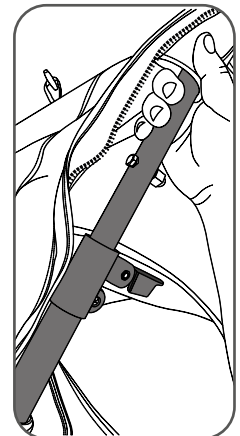
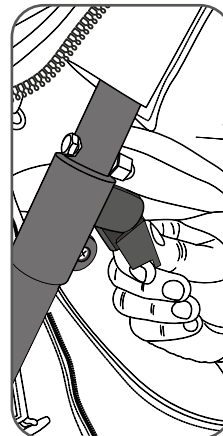

Step
5

- Install strut locks by snapping them onto the shaft of each side of strut. This can be done outside the tent or from inside the tent, reaching out the window.

⚠ The shell might need to be lifted slightly to allow for the strut lock to be inserted.

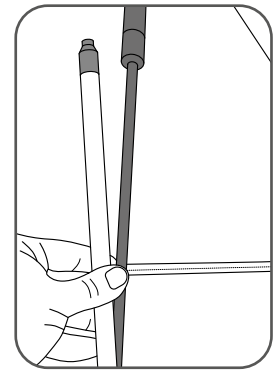

Step
6

- Setting up the Front Awning Poles

- a. At corner "A", Insert the end of the pole into the metal gourmet and pull the material tight, away from the tent body.

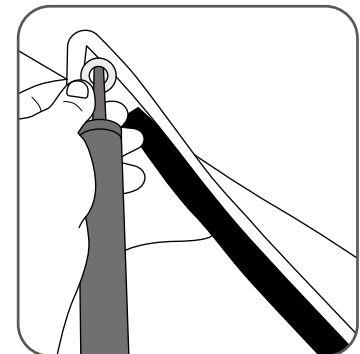
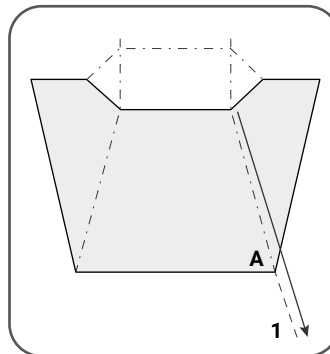

- b. Slide the figure 8 knot of the guy line over the post at the top of the pole.

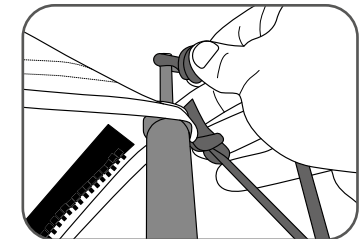

- c. Hammer a stake into the ground for guy line "1" about 7 feet away from the Awning Pole, you want about 45 to 65 degree angle for the guy line coming off the ground.

The guy line should be pulling directly away from the right corner of the rainfly U-bar.

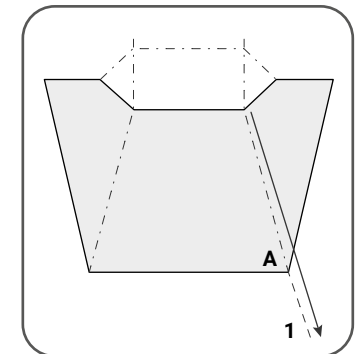

- d. Slip the tensioner loop of the guy line over the stake and apply a little tension by sliding the tensioner up, away from the stake.

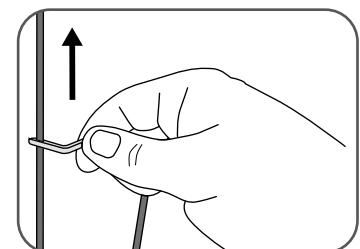

- e. Slide a second guy line, with the figure 8 end over the post at the top of awning pole "A".

- f. Hammer a stake into the ground for guy line 2 about 7 feet away from the Awning Pole, you want about 45 to 65 degree angle for the guy line coming off the ground. The guy line should be pulling directly away from the other front pole.

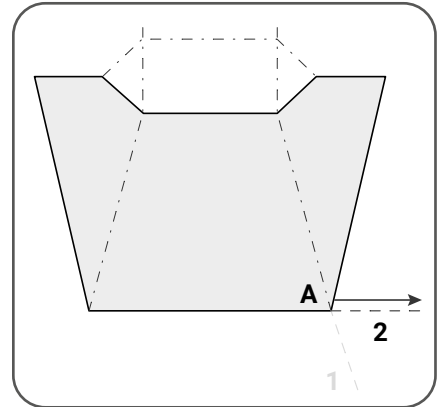

- g. Make sure the center tie down on the awning is centered with the center of the tent. Adjust the awning pole right or left while adjusting guy lines 1 and 2 to get the center of the awning aligned with the center of the tent.

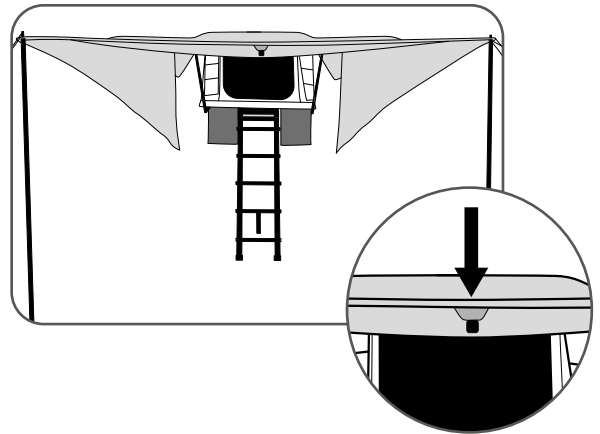

- h. At corner "B", Insert the end of the pole into the metal gourmet and pull the material tight, away from the tent body and away from Pole "A".

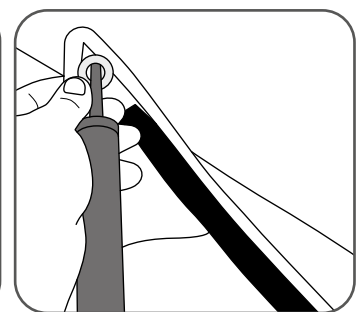
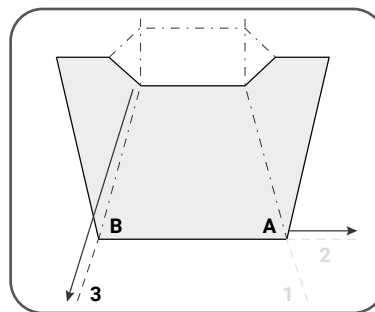

- i. Slide the figure 8 knot over the post at the top of the Pole.

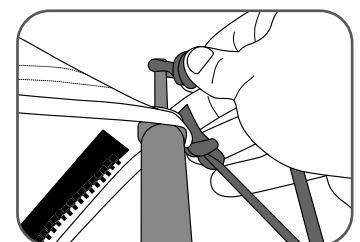

- j. Hammer a stake into the ground for guy line "3" about 7 feet away from the Awning Pole, you want about 45 to 65 degree angle for the guy line coming off the round. The guy line should be pulling directly away from the left corner of the rainfly U-bar.

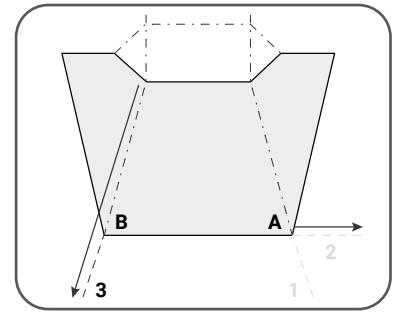

- k. Slip the tensioner loop over the stake and apply a little tension to guy line "3".

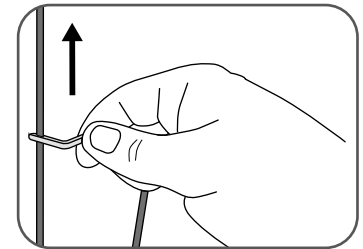

- l. Slide another guy line, with the figure 8 end over the post at the top of awning pole "B".

- m. Hammer a stake into the ground for guy line 4 about 7 feet away from the Awning Pole, you want about 45 to 65 degree angle for the guy line coming off the ground. The guy line should be pulling directly away from the other front pole.

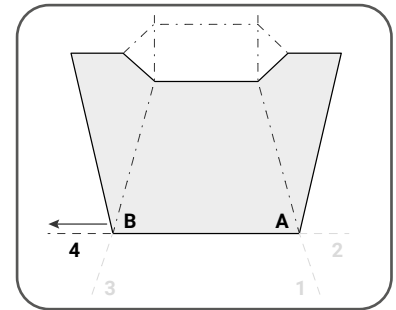

- n. Make sure the awning is still centered with the tent. Adjust Poles "A" and "B" if needed.

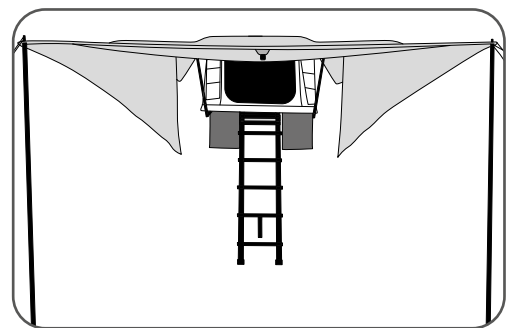

- o. Make sure the poles are vertical.

- p. Add tension to the guy lines 1 and 3.

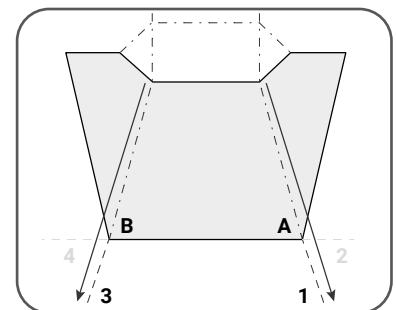

- q. Add Tension to guy lines 2 and 4.

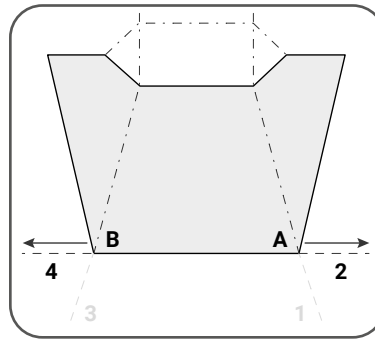

- r. The awning should be tight, have a good slope for drainage and be free of wrinkles or waves. Adjust Poles and tension to get the awning tight.

Step 7

- Setting up the side Awning Poles.

- a. Insert the end of the pole into the metal gourmet at corner "C" and pull the material tight, away from pole "A" and away from the tent body.

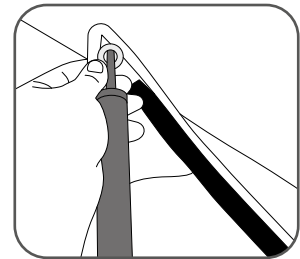
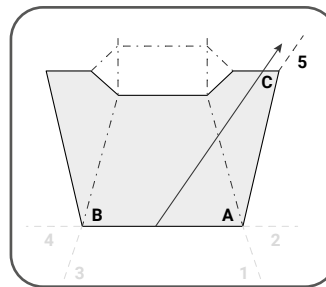

- b. Make sure the edge of the awning is tight between poles "A" and "C" and the rainfly side window is also tight.

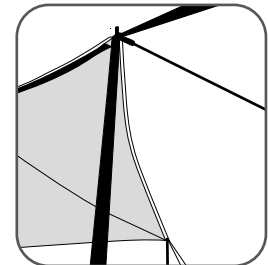

- c. Slide the figure 8 knot over the post at the top of Pole "C".

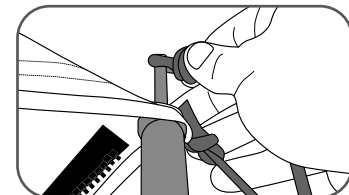

- d. Hammer a stake into the ground for guy line "5" about 7 feet away from the Awning Pole, you want about 45 to 65 degree angle for the guy line coming off the round. The guy line should be pulling away from the front center (between Poles "A" and "B")

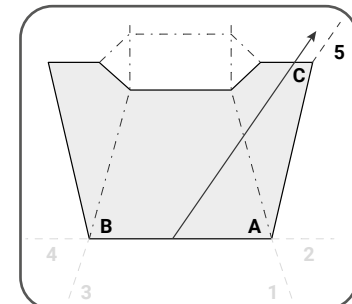

⚠ It is also possible to secure the guy line to the vehicle if desired.

- e. Slip the tensioner loop over the stake and apply a little tension to guy line 5.

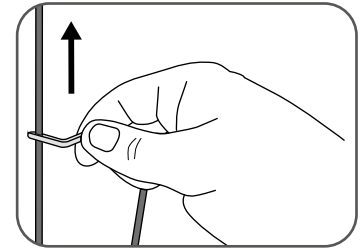

- f. Insert the end of the fourth pole into the metal gourmet at corner "D" and pull the material tight, away from pole "B" and away from the tent body.

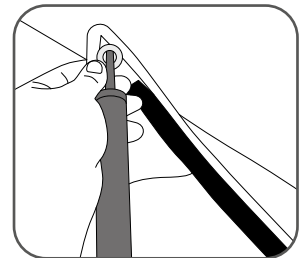
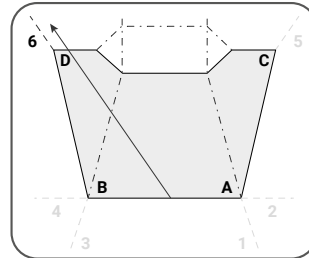

- g. Make sure the edge of the awning is tight between poles "B" and "D" and the rainfly side window is also tight.

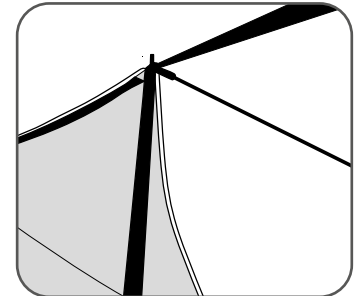

- h. Slide the figure 8 knot over the post at the top of Pole "D".

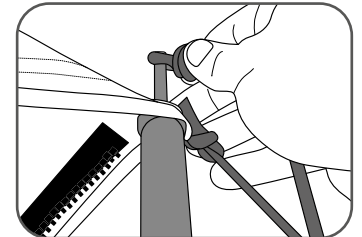

- i. Hammer a stake into the ground for guy line "6" about 7 feet away from the Awning Pole, you want about 45 to 65 degree angle for the guy line coming off the round. The guy line should be pulling away from the front center (between Poles "A" and "B").

⚠ It is also possible to secure the guy line to the vehicle if desired.

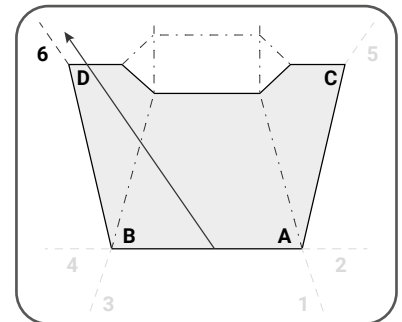

- j. Slip the tensioner loop over the stake and apply a little tension to guy line 6.

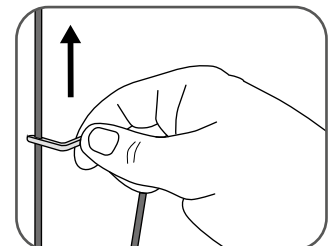

- k. Slide another guy line, with the figure 8 end over the post at the top of the awning pole "C".

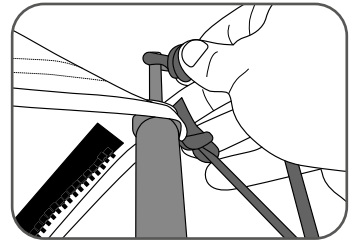

- l. Hammer a stake into the ground for guy line "7" about 7 feet away from the Awning Pole, you want about 45 to 65 degree angle for the guy line coming off the ground. The guy line should be pulling away from the Tent Body.

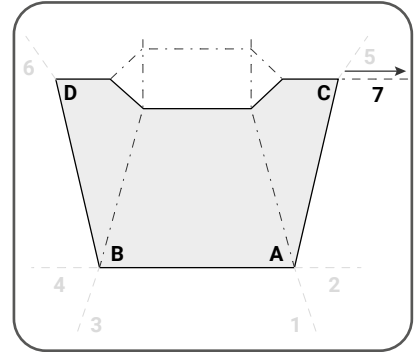

- m. Slide another guy line, with the figure 8 end over the post at the top of the awning pole "D".

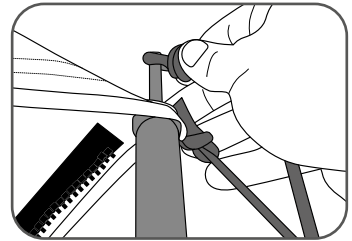

- n. Hammer a stake into the ground for guy line "8" about 7 feet away from the Awning Pole, you want about 45 to 65 degree angle for the guy line coming off the ground. The guy line should be pulling away from the tent body.

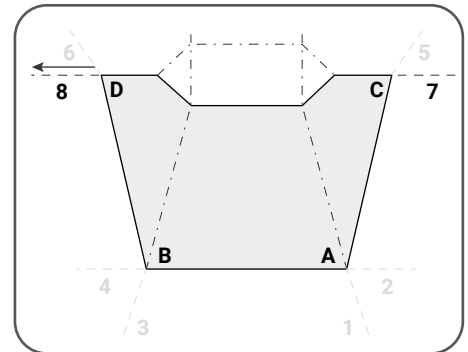

- o. Adjust awning poles "C" and "D" so they are vertical. Tighten the sides of the awning by tensioning Guy line 5 and then 6.

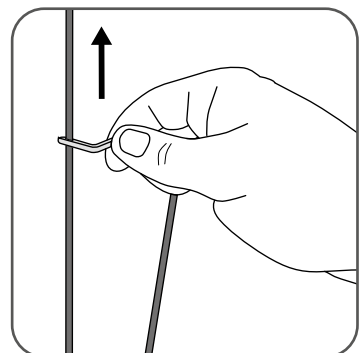
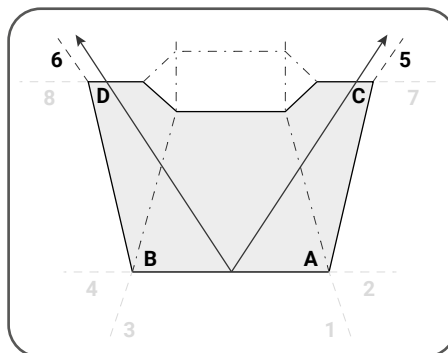

- p. Next, apply tension to guy lines 7 and 8.

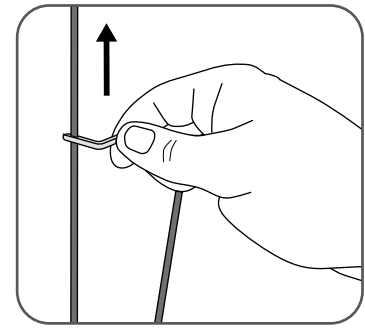
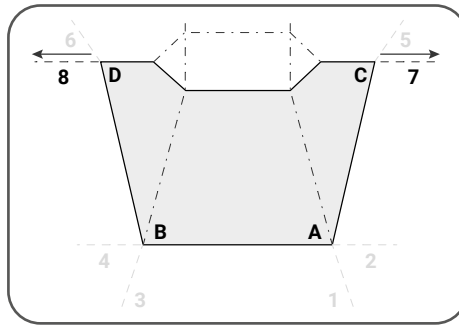

- ⚠ **The order in which you apply tension is very important.** If adjustments are needed after the Awning is all set up, loosen all the guy lines slightly and adjust the awning poles if needed. Tension the guy lines in the following order: 1, 3, 2, 4, 5, 6, 7, and then 8. After tension is applied, adjust the Awning poles so they are vertical.
- ⚠ When tightening the guy lines, the zipper may unzip between the awning and the rainfly. Loosening guy line 3 and/or 5 a little will help the zipper stay zipped.
- ⚠ The 9th stake and guy line can be used to allow for better drainage by attaching it at the center of one awning openings.



Move the LED above the tent door to the Rainfly ubar (there is a velcro strip there also) to provide light to the awning. Be sure to move the LED back to the tent body before closing the Awning to prevent the LED cord from getting damaged.

- ⚠ During rain storms or snow, the Awning should be checked occasionally to make sure water is not pooling.

Putting your Awning Away

Step
1

- The order in which you loosen the guy lines is not important.

Step
2

- Remove the top of the guy lines from the Awning poles



Leave the guy lines attached to the stakes until you are ready to pull them out of the ground. This will help to not lose the stakes and using the guy line to pull the stakes out of the ground is helpful.

Step
3

- Fold up the awning poles and place them in the storage bag.

Step
4

- Pull the stakes out of the ground and place them in the storage bag.



Hitting the stakes with a hammer side to side will help loosen them from hard ground.

- ⚠ Stakes are considered a wear item. They will get bent from hammering them in the ground and can be straightened by placing them on a hard durable surface (think workbench, a rock, or concrete) and hitting the side of them with a hammer. Replacement stakes can be found at any outdoor or hardware store.

Step
5

- Roll up each guy line individually so they don't become tangled (you do not need to remove the knots or tensioners). Place them in the storage bag.

Step
6

- Unzip the awning from the tent and roll or fold up the awning. Place it in the storage bag.

- ⚠ The awning should be clean and dry before storing. It is recommended if your awning is wet, you temporarily store it out of the storage bag until it is fully dry.



The Awning can be stored inside the Condor 2/ Condor Overland 2 tents in the bedding storage bag.

Troubleshooting



ISSUE	SOLUTION
The Awning is sagging or water is pooling	Make sure the awning is correctly aligned. Loosen the guy lines. Tighten guy lines in this order: 1,3,2,4,5,7,6, and 8.
	Make sure the ground the awning is set up on is relatively level and the Awning Poles are not in holes or mounds.
	Make sure the strut locks are installed.
	Make sure the ladder is properly set up and is not allowing the platform to sag.
Awning zipper keeps unzipping	Adjusting the awning pole and loosen guy lines 1 and 5 will help keep the zipper in pace.
	Make sure the Awning/rainfly are centered on the Rainfly U-bar.
Awning loosens up when someone is in the tent	Some loosening is common because the vehicle suspension is compressing.
	Make sure the Ladder is adjusted correctly and does not allow the fold out platform to bounce.
	Make sure the strut locks are installed correctly.
Stakes keep pulling out of the ground	Hammering the stakes at a 45 degree angle, away from the awning will help secure them.
	Change the angle the guy lines are coming off the awning pole by moving the stake further away from the pole.
	If setting up the Awning in sand or loose dirt, placing a large rock over the stake will help secure it.
	Purchasing sand stakes that have a V shape design will help with loose dirt or sand.
I cannot hammer the stake into the ground, it is too rocky or hard	Using an alternative anchor is the best option. This could be a stack of rocks, water jugs, or a tree. It is recommended that if you are attaching to a pile of rocks, to swap the guy lines around so the figure 8 is used as a loop to go around a rock and the tensioner end is used at the top of the pole.

Instructions for the Wall Kit

 You will need to purchase the Condor 2 Awning separately to be able to use the wall kit.

What is included

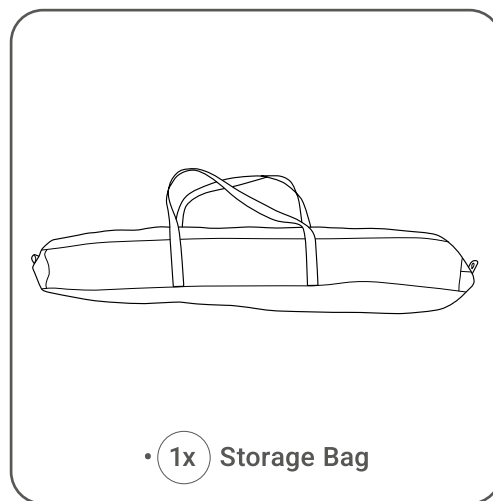
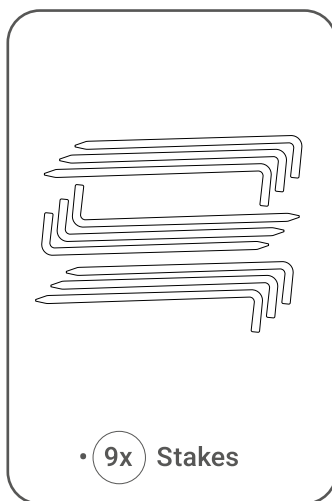
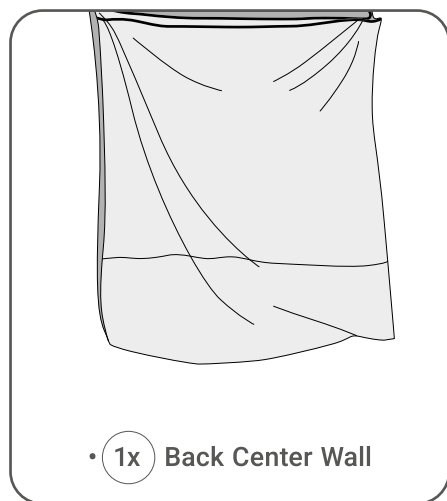
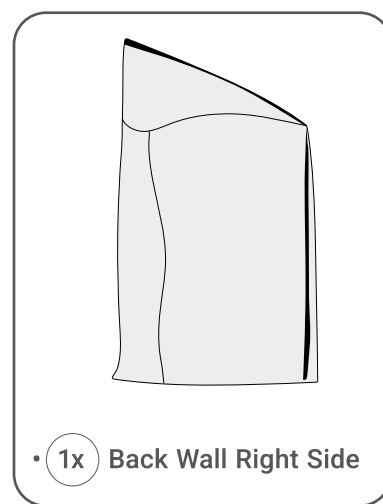
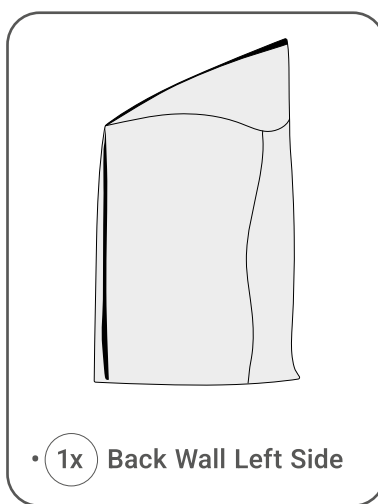
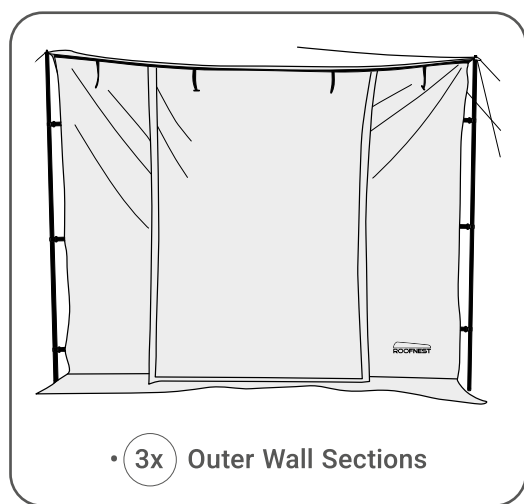

- Before installing one or all the wall sections, make sure the tent is properly set up and the Awning is installed correctly.

Outer Wall Sections

Step
1

- Locate one of the outer wall sections.

Step
2

- Locate the zipper pull on the top of the wall section. Move the zipper pull to the left end of the zipper when facing the outside of the wall. The logo in the bottom right corner should be facing out and readable.

Step
3

- Zip the wall section into the awning.

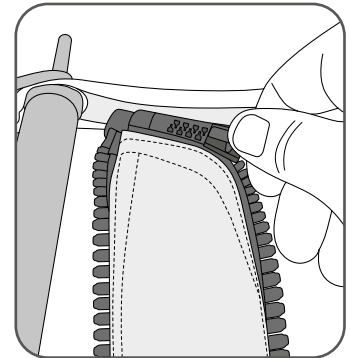

Step
4

- The ends of the wall section have clips to attach to the awning poles. Attach the 3 clips per side.

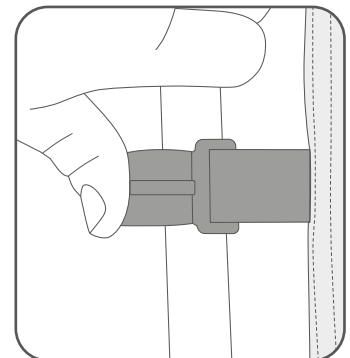

Step
5

- Repeat this process for the remaining outer walls. The outer walls are interchangeable and fit any of the outside wall sections.



PRO TIP

The outer walls can also be zipped together to close off the awning.

Step
6

- The bottom of the wall has loops to go around the awning poles. The poles will need to be lifted slightly to place the loops underneath.

- ⚠ The awning and walls will have small gaps at the top corners. This can let some bugs in. If sealing the Awning off is desired, we recommend applying tape to these corners.

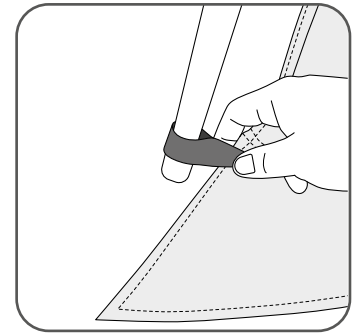

Step
7

- Stakes can be added to the metal grommets to secure the walls to the ground.

- ⚠ The bottom of each wall section has a 6" skirt to help keep the weather out. The skirt should be kept on the outside of the enclosure.

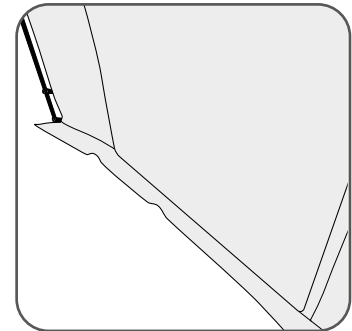

The Doors can be rolled up and so can the bug mesh. The doors can also be secured as an additional awning using poles (sold separately) or tied off to trees or other structures.

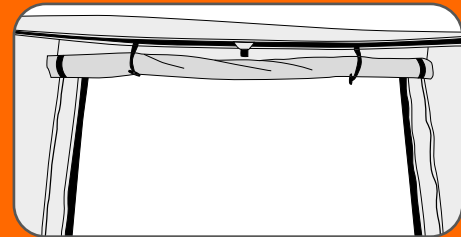

- The entire wall section can also be rolled up. To do this, unzip the corners of the wall section and unclip from the Awning Pole. Remove the loops from around the Awning pulls and remove stakes if installed. Roll the wall up from the outside and fold the bottom corners into the middle. Use the pole at the bottom of the door material to roll from. There are 4 loops and toggles at the top of the wall for storage.

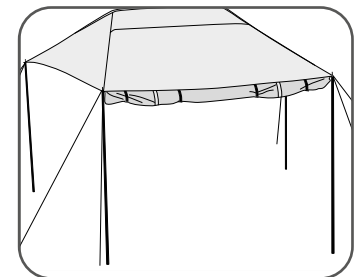

- When storing the outer wall sections, it is recommended that you first roll up the wall and secure the loops and toggles. After the wall is secured, unzip from the awning. Store rolled up in the storage bag. This will make setting up the wall sides easier the next time. When installing again, zip onto the awning and then unroll the wall section.

Back Center Wall Section

The back Center wall section has a velcro opening that needs to pass around the ladder.

Step
1

- Locate the Back Center wall section.

Step
2

- Lay the material behind the ladder with the zipper pull to the left side and the orange trim around the velcro opening at the top center of the back wall.

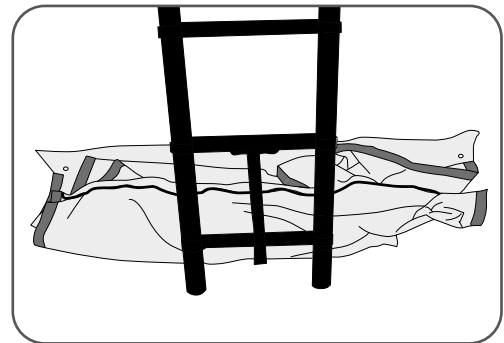

Step
3

- Open the Velcro pass through.

Step
4

- Lift the bottom of the Ladder up and pass the ladder through the velcro opening, lower the ladder back to the ground and make sure all the rungs are locked out.

- ⚠ The zipper end should be on the front face of the ladder with the rest of the material behind the ladder.

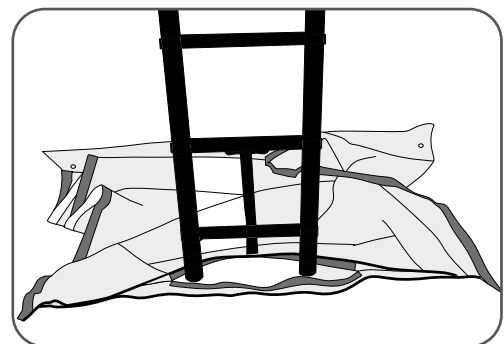

Step
5

- Move the material up the ladder and attach to the front edge of the fold out platform zipper. Roll the excess material at the bottom up and fold it so it is inside the awning enclosure.

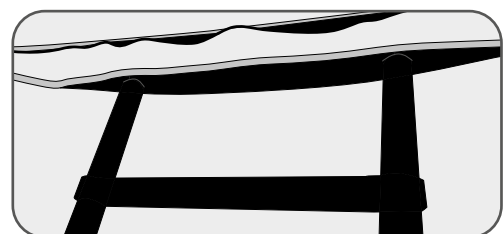

Step
6

- Velcro the opening closed around the ladder.

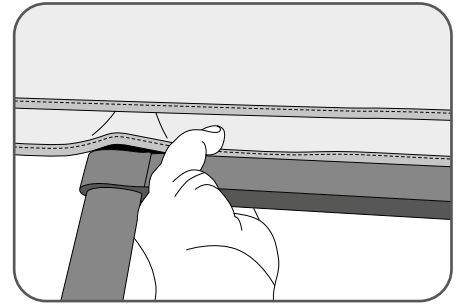

Left and Right Back Wall Sections

You can tell the left from the right by having the clips that attach to the Awning pole on the outside and the zipper on the inside.

There is also webbing adjustment straps that should be on the inside of the enclosure.



A small step ladder or something to stand on (safely) help to secure the left and right back wall sections. We do not recommend leaning out the tent door to make the attachments.

Step
1

- Locate the left wall section.

Step
2

- There are two zipper sections that attach to the Awning Material and also the Rainfly side window. Attach the top of the Awning by attaching it to the two zippers.

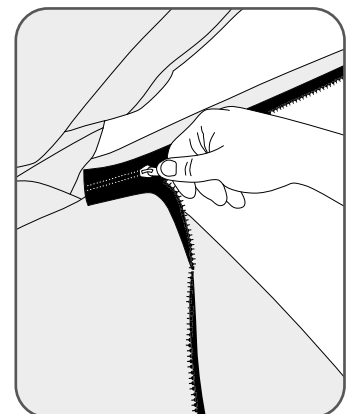
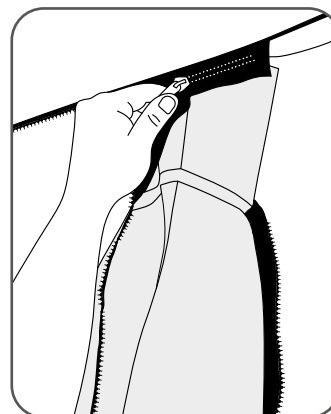

Step
3

- Clip the side onto the Awning pole and zipper to the Outside wall.

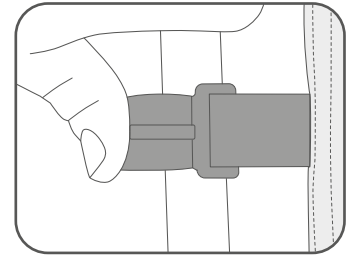

Step
4

- Attach the back side wall to the outer side wall using the zipper.

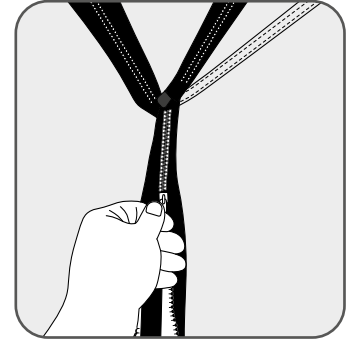

Step
5

- Attach the velcro top edge to the velcro strip on the tent material, starting on the top corner and working down. Stop about ½ way.

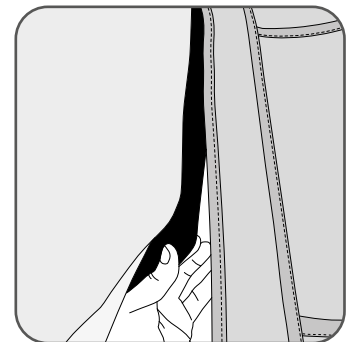

Step
6

- Starting from the bottom of the velcro strip, align the seam of the back side wall with the bottom of the Fold Out Platform on the tent. Work your way up attaching the velcro, letting the excess material fold behind the material.

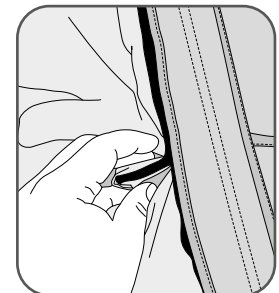

Step
7

- Adjust the webbing so the seam of the back left wall is level with the fold out platform and the bottom edge of the wall section is even with the ground.

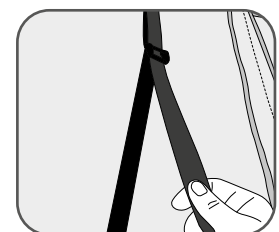

**Step
8**

- To attach the Back Side Wall to the Back Center Wall, start from the top and work your way down until you reach the ground.

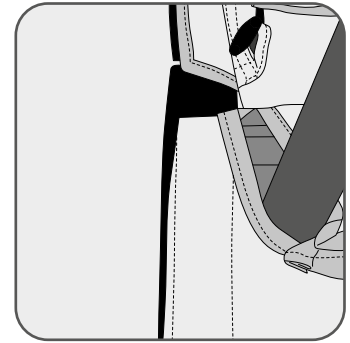

**Step
9**

- Using Stakes, secure the excess material to the ground. The Back Side Walls should be adjusted so the grommets are near the ground.

The Center section may have excess material that can be folded or rolled up.

**Step
10**

- Repeat the above steps for the right side back wall section.

Troubleshooting

ISSUE	SOLUTION
The walls are sagging	Refer to tightening the guy lines in the Awning install section.
	Make sure the Strut locks are installed. If not, reinstall them.
	Make sure your stakes are still secure in the ground. Restake the corners if the stake came out. Following the Guy line tensioning process in the Awning install section.
I can't figure out which side is the left or right on the back wall sections.	The adjustment straps should be on the inside of the enclosure. See Left and Right install section of this manual.

Install Instructions for the Condor Awning Floor

What is included

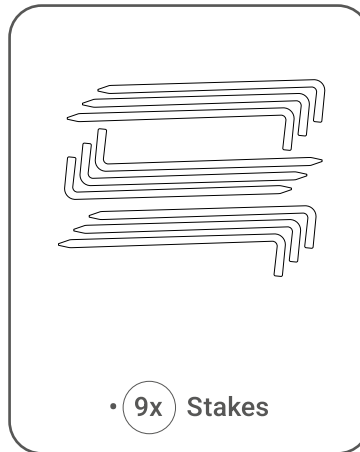
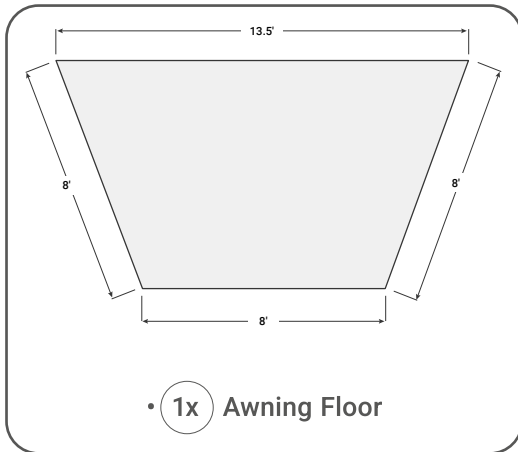

Because the Awning is designed to be compatible with varying mounting heights, the floor may have a gap around the edge of the enclosure or extend under the Wall skirts.

Step 1

- Place floor under the awning and secure the front edge (furthest from the tent opening) by placing the loops under the awning poles by lifting the poles slightly.

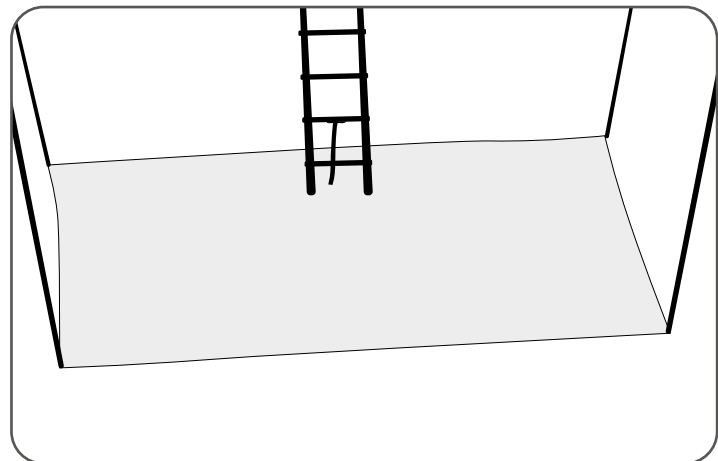

**Step
2**

- Lift the ladder by collapsing one rung and then sliding the floor underneath the ladder. Pull tight away from the front Awning pulls.
-

**Step
3**

- Extend the ladder and make sure the rung is secure.
-

**Step
4**

- Place the back edge loop around the Awning pulls if possible. If it is not possible, stake the corners down.
-

**Step
5**

- Stake the center sections of the floor down.

 **The floor is constructed of heavy duty PVC material. This material is waterproof and will not allow moisture to come up from the ground.**

It will also prevent any moisture from being able to escape (except around the edges). Make sure the floor does not extend outside of the enclosure or there is a chance water from the outside will come inside and pool.

 **The PVC material can be damaged if placed over rocky surfaces and walked on. It can also be damaged by shoes or boots that have rocks trapped in the soles.**

The floor is made of heavy duty material but should be considered a wear item that may need to be replaced after extended usage.

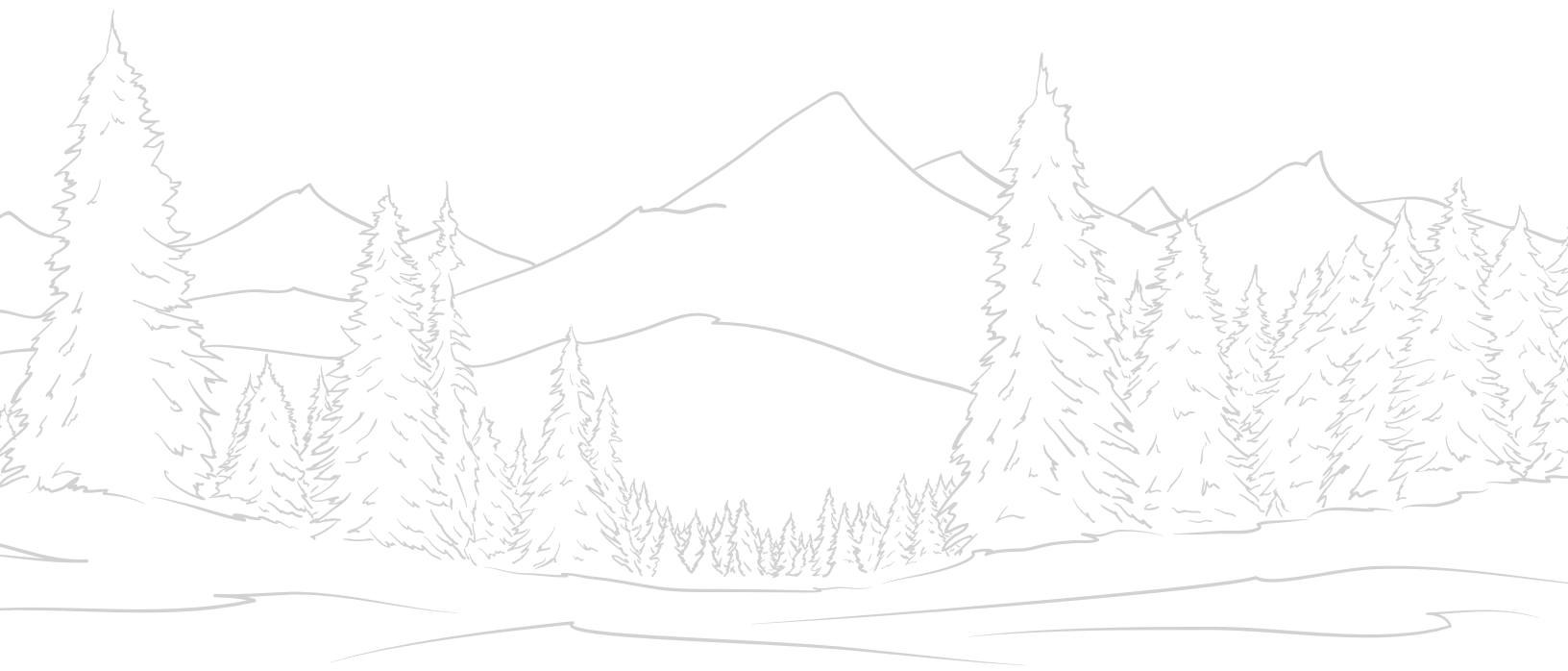

Thank you for being a Roofnest customer!

Please stay in touch and let us know where your travels take you – we love to get photos! We also have a great community online where customers post photos, share stories, tips, and good vibes – the Roofnest Flock – find it on Facebook by searching for “Roofnest Flock”.



e: support@roofnest.com
p: (303) 502-5406
roofnest.com

Now go camping and enjoy!
Share Your Adventures #Roofnest

